

47xxN Series Time Zone Display

Operating and Installation Instruction

Issue 2.2



Contents

1 Introduction	Page 3
2 Installation and Operation	Page 4
3 Function Programming	Page 5
4 Time and Date Setting	Page 6
5 Location Setup	Page 7
6 Network Setup	Page 10
7 Synchronisation Setup	Page 11
8a Display Setup (472xN and 474xN series)	Page 14
8b Calendar Setup (470xN and 475xN series)	Page 15
9 Stopwatch Setup	Page 16
10 External Interface Setup	Page 17
11 System Setup	Page 17

47xxN Series Time Zone Display Operating and Installation Instructions

© 2012 - 2017 Wharton Electronics Ltd, All rights reserved.

Trademarks

Wharton Electronics and 4700N and 4700NIL are trademarks of Wharton Electronics Ltd. MOBALine is a registered trademark of Moser Baer AG. All other trademarks and registered trademarks are property of their respective owners.

Statutory Notices

Warning - To prevent fire or shock hazard, do not expose the internals of the unit to rain or moisture.

Disposal of Lithium battery - This equipment has a built-in Lithium (Li) battery which in normal operation should have a service life greater than 10 years.



CAUTION - Danger of explosion if battery is incorrectly replaced.

Replace only with the same or equivalent type recommended by the manufacturer. Dispose of used batteries according to the manufacturer's instructions. You can return your unwanted Lithium batteries to the manufacturer or their agent. Note: In some areas disposal of Lithium batteries in household or business waste may be prohibited. Caution: Do not handle damaged or leaking Lithium batteries. To remove battery at end of product's life, unscrew backplate from case body to remove (top rail in case of double sided unit), locate Lithium battery on main driver board and remove. Battery should be disposed of as per local legislations.

End of Life - At the end of product's life, do not dispose of your device in the regular domestic/household waste. Return your device to your supplier who will dispose of it correctly.



Electromagnetic Compatibility & Safety

For Customers in Europe:

47xxN series time zone displays, when used in accordance with our recommendations, complies with the European Community Electromagnetic Compatibility Directive 2004/108/EC and the European Community Low Voltage Directive 2006/95/EC and conforms to the following standards:

EN 61000-6-1

EN 61000-6-3

EN 60950

For Customers in the USA

The equipment has been designed to comply with the limits for a Class B digital device, pursuant to Part 15 of the FCC Rules. These limits are designed to provide reasonable protection against harmful interference in a residential installation. The equipment generates, uses and can radiate radio frequency energy and, if not installed and used in accordance with the instructions, may cause harmful interference to radio communications. However, there is no guarantee that interference will not occur in a particular installation. If this equipment does cause harmful interference to radio or television reception, which can be determined by turning the equipment off and on, the user is encouraged to try and correct the interference by one or more of the following measures:

- Re-orientate or relocate the receiving antenna.
- Increase the separation between the equipment and receiver.
- Connect the equipment into an outlet on a circuit different from that to which the receiver is connected.
- Consult the dealer or an experienced radio/TV technician for help.

You are cautioned that any changes or modifications not expressly approved in this manual could void your authority to operate this equipment.

Warranty

The 47xxN series time zone displays are fully guaranteed, on a return to works basis, against failure due to faulty parts or workmanship for 24 months from date of purchase. In the event of failure, either within or outside the warranty period, please pack the unit with care and return to the manufacturer, or their agent, for examination and repair.

In no event shall the manufacturer, or their agent be liable for any direct, incidental or consequential damages of any nature, or losses or expenses resulting from any defective product or the use of any product, irrespective of whether the manufacturer, or their agent, has advance notice of the possibility of such damages.

Product Development

In the interests of improving design, operational function, and/or reliability, Wharton Electronics Ltd reserves the right to make changes to the products described in this document without notice.

This manual version 2.1 applies to units operating with software version 02.05 or later, unless otherwise stated.

1 - Introduction

The 47xxN series time zone displays provide a precise and elegant display of time using red, green, yellow/amber, blue or white LED display characters with an unrivalled flexibility of operation in the most demanding timekeeping and stopwatch applications.

All units can be used in stand-alone applications, while 47xxN products are primarily intended to be synchronised via NTP/SNTP from a remote time server located on the customers TCP/IP Ethernet network. In addition, 47xxN units can be configured for over 30 different types of secondary clock operation, included GPS, MSF or DCF radio time code synchronisation when used with the appropriate option module or radio receiver..

The 47xxN series time zone displays can display static time display; alternating time and date or alternating time and temperature; or alternating time, date and temperature. (Please note, temperature display only available on 47xxN series units and requires connection of 406 temperature sensor.)

All of the digital clocks also have the ability to operate as a multi-range programmable stopwatch using supplied infrared remote control or using an external stopwatch control panel or user supplied voltage free contact closure or switch.

Simple Operation

All 47xxN series time zone displays are supplied with an infrared remote control to allow for easy setup and control of stopwatch functions. The units are simple to configure and will automatically adjust themselves for seasonal daylight savings time changes (as required).

Operating Features

The 47xxN series time zone displays offer the following operating features.

- 83 preset location codes - The digital clock may be user programmed to display the time in one of 83 different preset locations.
- User programmable time zone - To allow for custom time zones or future changes in legislation
- Automatic or manual brightness - The display may be programmed to one of seven preset display brightness levels. Alternatively, the unit may be programmed for automatic display brightness where the display illumination level is reduced as the ambient light level decreases -
- Multi-function Stopwatch - The display can be configured to operate as a count-up or count-down stopwatch with a the display freely switchable between operating modes or fixed to either stopwatch or clock display.

Installation and Operation

Power Supply Connection

The 47xxN series time zone displays are fitted with either universal mains power supplies (enabling operation at voltages from 100 to 240V AC 50/60Hz without adjustment).

Units are supplied with a 2m mains cable preterminated with a UK style moulded plug (units for supply to the USA or Canada are supplied with a 2m captive mains cable preterminated with a US style moulded plug).

A connection to the earth line must be made to ensure safe operation and compliance with EMC regulations.

To ensure conformance with EN60950:

- A. For installations where the 47xxN series time zone display is to be permanently connected into the mains power circuit, a readily accessible disconnect device should be incorporated in the fixed wiring.
- B. For installations where the 47xxN series time zone display is to be plugged into the mains power circuit, a socketed outlet should be installed near the equipment and should be easily accessible.

All installation work should be performed in accordance with current Building Regulations and the Seventeenth Edition of the IEE Wiring Regulations, or equivalent local standard.

The power supply is fitted with an internal fuse. In case of fault the fuse should only be replaced with a fuse of the same rating, by a suitably qualified engineer after disconnection from the mains power supply and correction of the fault condition.

Remote Control and Rear Switches

In addition to the rear setting switches, the 47xxN series time zone displays are supplied with an Infrared Remote Control to allow for easy setting of the unit.

- 1 'Up' - Used to navigate up through setting menus or access Function Menu when time is displayed.
- 2 '+' - Used to increment setting options.
- 3 '-' - Used to decrement setting options.
- 4 'Down' - Used to navigate down through setting menus.
- 5 'Menu' - Used to access Function Menu on clock.
- 6 'Exit' - Used to exit from any clock setting menu to normal clock display.
- 7 'Start/Stop' - Only used in Stopwatch Mode. See Section 9 for further information
- 8 'Hold/Reset' - Only used in Stopwatch Mode. See Section 9 for further information.
- 9 'Clock Mode' - Used to place clock into Clock Mode. See Section 9 for further information.
- 10 'Stopwatch Mode' - Used to display Stopwatch Mode. See Section 9 for further information

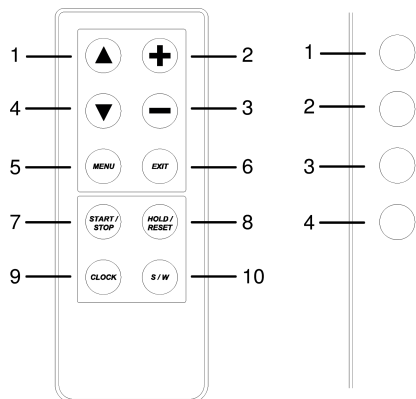

3 - Function Programming

The 47xxN series time zone displays have a user friendly programming interface based around a series of function menus, accessed using the supplied Infrared remote control or four switches located on the right hand rear of the display. The function menus may be accessed as detailed in the drawing below. This drawing illustrates the menu display for both seven segment and dot matrix display units.

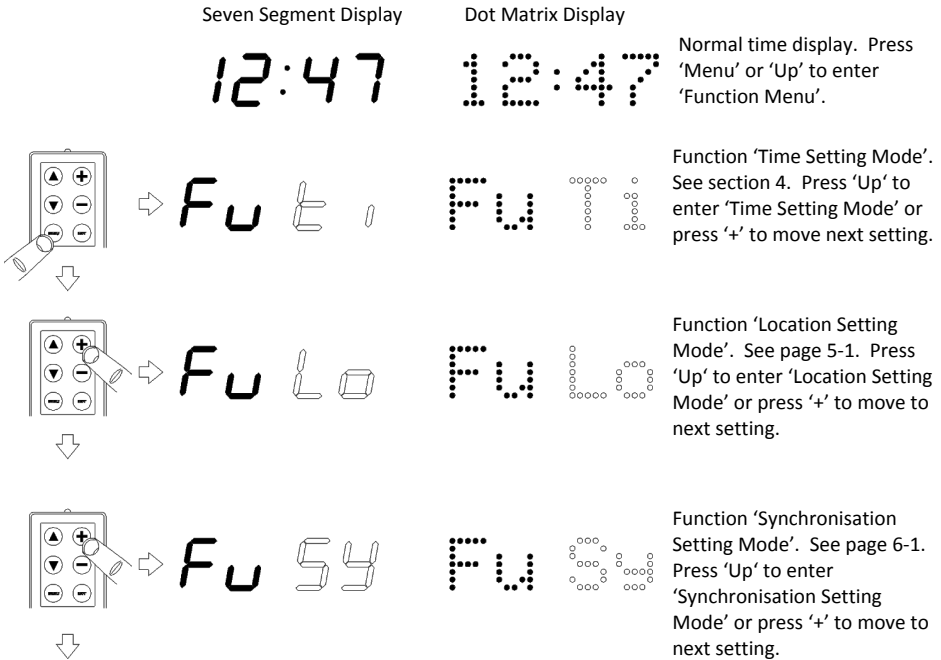

The other function menu options are detailed in the table below.

Function Menu Options	Function	Section
Ti	Time and Date Setup - Manually set time and date on unit.	4
Lo	Location Code Setup - Select UTC offset and seasonal time change rules.	5
Sy	Synchronisation Mode Setup - Select synchronisation mode.	7
Nt	Ethernet Setup - Select network settings.	6
Cl or Di	Calendar / Date format Setup - Select calendar/date format.	8
SS	Stopwatch Setup - Select stopwatch settings.	9
Et	External Interface Setup - Select operating mode of external interface.	10
St	System Setup - Select brightness level (br) and 12/24 hour display format.	11

4 - Time and Date Setting

The 47xxN series time zone displays can be configured to automatically adjust for daylight savings changes, however if the unit is run in Standalone mode of operation (i.e. unsynchronised), you may occasionally need to manually adjust the time. Please refer to the diagram below for further information.



Function 'Time Setting Mode'. Press 'Up' to enter 'Time Setting Mode' and set the seconds count.

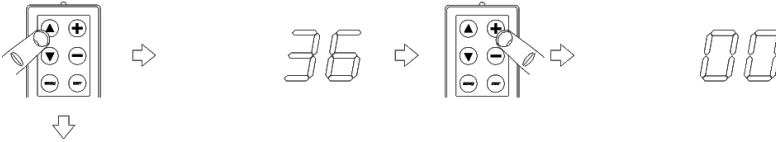

Seconds Setting Mode. Press '+' to increment seconds, '-' to set to zero. Press 'Up' to set minutes count.

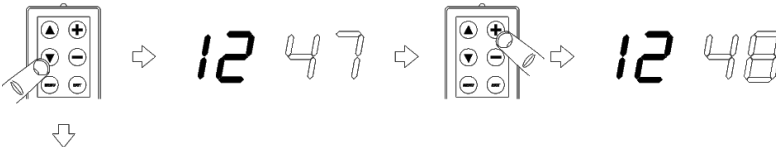

Minutes Setting Mode. Press '+' or '-' to increment or decrement minutes. Press 'Up' to set the hours count. Complete time setting process detailed in table below.

Fu Ti Function	Time and Date settings Display Type hh:mm	Description	'Up' button function
Second	36	Set second (minus button zeros seconds).	Select minutes
Minute	12 47	Set minute.	Select hours
Hour	12 47	Set hour.	Select year
Year	20 14	Set year.	Select month
Month	26 06	Set month.	Select day of month
Day of Month	26 06	Set day of month.	Select Leap Second
Leap Second	LS No	Enable leap second - 59, No or 61. (Please leave at 0 unless a leap second is scheduled)	Exit to Time Display

5 - Location Setup

The 47xxN series time zone displays provide advanced time zone functionality where the display may be user programmed to automatically indicate the time in one of 83 preset locations. Incorporating 'Set Once' technology, the 47xxN series time zone displays will automatically calculate future seasonal time changes for all preset time location code settings.

Setting the Location

If you wish to alter the time zone displayed on your 4700x series time zone display, rather than manually adjusting the time, the location code should be adjusted as detailed in the table below.

The location settings are accessed from the function menu as detailed in section 3.

Each time display can be independently configured to display a different world time. The 47xxNIL series units have illuminated location legends are user programmable.

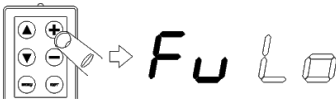

Function 'Location Setup Mode'. Press 'Up' to enter 'Location Setup Mode' and select location to adjust.

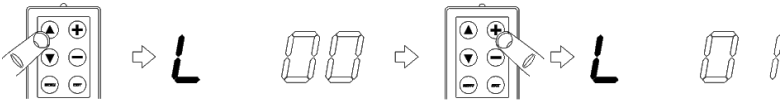

Select required Location Code for zone. Press 'Up' to select Illuminated Location Legend Mode (or exit to Location Menu if unit has fixed locations).

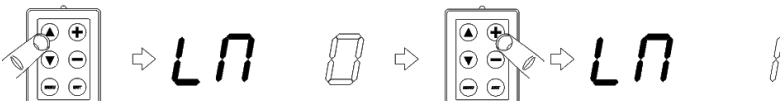

Select required Illuminated Location Legend Mode. '0' = user programmable legend, '1' = calendar display. Press 'Up' to set location legend (or exit to Location Menu is Calendar mode is selected).



Select required Location Legend characters. '+' or '-' to scroll through available characters. 'Up' button to select next character or 'Down' to select previous character. Select '!' to confirm selection and exit to Location Menu.

47xxN Series Time Zone Display Operating and Installation Instructions

Fu Lo Function	Location settings Display Type hh:mm	Description	'Up' button function
Location	L 01	Select zone to configure.	Select desired zone
Location Code	L 01	Set Location Code for zone.	Exit to Location Menu or select location legend display mode (47xxL units only)
Location Display Mode	LM 0	Set location display mode. 0 = User Programmable Text 1 = Calendar Display	Exit to Location Menu or select programmable text (LM 0 only)
Location Display Text	Prog	Select location display mode text '+' and '-' to select character 'Up' to move to next character 'Down' to move to previous character Select '!' to confirm selection	Exit to Location Menu.

The table below details the time displayed for each location code.

Time Zone Locations				
Code	Time Zone / City / Location	UTC Offset	Seasonal Time Change	
00	UTC+0 (ZULU) UTC, GMT	0	No	
01	WET/WEST GMT/BST London, Lisbon	0	Yes	
02	UTC+1 (ALPHA) WAT Luanda, Angola	1	No	
03	CET/CEST MEZ/MESZ Brussels, Frankfurt	1	Yes	
04	UTC+2 (BRAVO) SAST Jo'burg, Pretoria, S Africa	2	No	
05	EET/EEST Greece - Athens, Ukraine - Kiev	2	Yes	
06	IST/IDT Israel - Tel Aviv	2	Yes	
07	MSK-1 Russia - Kaliningrad	3	No	
08	UTC+3 (CHARLIE) AST Iraq - Baghdad, S Arabia - Riyadh	3	No	
09	MSK Russia - Moscow	4	No	
10	IRST/IRDT Iran - Tehran	3	Yes	
11	UTC+4 (DELTA) GST UAE - Dubai, Abu Dhabi	4	No	
12	AZT/AZST Azerbaijan - Baku +4 hours offset	4	Yes	
13	AFT Afghanistan - Kabul	4 1/2	No	
14	UTC+5 (ECHO) TMT Turkmenistan - Ashgabat	5	No	
15	PKT Pakistan - Islamabad	5	No	
16	YEKT, MSK+2 Russia - Yekaterinburg	6	No	
17	IST India - New Delhi, Mumbai	5 1/2	No	
18	UTC+6 (FOXTROT) BST Bangladesh - Dhaka	6	No	
19	OMST, MSK+3 Russia - Omsk	7	No	
20	MMT Myanmar - Naypyidaw	6 1/2	No	
21	UTC+7 (GOLF) WIB Indonesia - Jakarta	7	No	
22	KRAT, MSK+4 Russia - Krasnoyarsk	8	No	
23	UTC+7.5	7 1/2	No	
24	UTC+8 (HOTEL) CST - Beijing, WITA - Central Indonesia, WST Australia - Perth	8	No	
25	IRKT, MSK+5 Russia - Irkutsk	9	No	
26	UTC+9 (INDIA) JST Japan - Tokyo, WIT - Eastern Indonesia	9	No	
27	YAKT, MSK+6 Russia - Yakutsk	10	No	
28	CST Australia - Darwin	9 1/2	No	
29	CST/CDT Australia - Adelaide	9 1/2	Yes	
30	UTC+10 (KILO) EST Australia - Brisbane, ChST Guam	10	No	
31	EST/EDT Australia - Sydney, Tasmania - Hobart	10	Yes	
32	VLAT, MSK+7 Russia - Vladivostok	11	No	
33	UTC+10.5	10 1/2	No	
34	UTC+11 (LIMA) SBT Solomon Is. - Honiara	11	No	
35	MAGT, MSK+8 Russia - Magadan	12	No	
36	UTC+12 (MIKE) MHT Marshall Is. - Majuro, Kwajalein	12	No	
37	NZST/NZDT New Zealand - Wellington, Auckland	12	Yes	
38	TKT Tokelau - Fakaofu	13	No	

47xxN Series Time Zone Display Operating and Installation Instructions

39	LINT Line Is.- Kiritimati	14	No
40	UTC-13	-13	No
41	UTC-12 (YANKEE)	-12	No
42	UTC-11 (X-RAY) Midway Is.	-11	No
43	UTC-10 (WHISKEY) HAST Hawaii - Honolulu	-10	No
44	UTC-9 (VICTOR)	-9	No
45	AKST/AKDT US - Alaska, Anchorage	-9	Yes
46	UTC-8 (UNIFORM) PST US - Pitcairn Is.	-8	No
47	PST/PDT US - Pacific, L.A.	-8	Yes
48	UTC-7 (TANGO) US - Arizona, Phoenix	-7	No
49	MST/MDT US - Mountain, Denver	-7	Yes
50	UTC-6 (SIERRA) Costa Rica - San Jose	-6	No
51	EST/CST Mexico - Mexico City	-6	Yes
52	CDT/CST US - Central, Chicago	-6	Yes
53	UTC-5 (ROME) PET Peru - Lima	-5	No
54	EST/EDT US - Eastern, New York	-5	Yes
55	VET Venezuela - Caracas	-4 1/2	No
56	UTC-4 (QUEBEC) BOT Bolivia - La Paz	-4	No
57	CLT/CLST Chile - Santiago	-4	Yes
58	ADT/AST US - Atlantic	-4	Yes
59	PYT/PYST Paraguay - Asuncion	-4	Yes
60	UTC-3.5	-3 1/2	No
61	NST/NDT US - Newfoundland	-3 1/2	Yes
62	MIL-PAPA ART Argentina - Buenos Aires	-3	No
63	BRT/BRST Brazil - Brasilia, Sao Paulo	-3	Yes
64	WGT/WGST Greenland (West) - Nuuk	-3	Yes
65	PMST/PMDT US - Pierre & Miquelon	-3	Yes
66	UYT/UYST Uruguay - Montevideo	-3	Yes
67	UTC-2.5	-2 1/2	No
68	UTC-2 (OSCAR)	-2	No
69	UTC-1 (NOVEMBER) CVT Cape Verdi - Praia	-1	No
70	AZOT/AZOST Portugal - Azores	-1	Yes
71	EGT/EGST Greenland (East) - Ittoqqortoormit	-1	Yes
72	Morocco - Rabat, Casablanca	0	Yes
73	WT/WST Western Sahara - El Aaiún	0	Yes
74	Namibia - Windhoek	1	Yes
75	Egypt - Cairo	2	No
76	Gaza - Gaza	2	Yes
77	Jordan - Amman	2	Yes
78	Lebanon - Beirut	2	Yes
79	Syria - Damascus	2	Yes
80	West Bank - Bethlehem	2	Yes
81	NPT Nepal - Kathmandu	5 3/4	No
82	FJT/FJST Fiji - Suva	12	Yes
83	SST Samoa - Apia	13	Yes
94	Temperature Display A (47xx world time zone display only)		
96	Stopwatch display (47xx world time zone display only)		
98	Custom location code		
99	Blank display (47xx world time zone display only)		

User Programmable Time Zone

To allow for custom time zones and future changes in legislation, setting the unit to location code 98 enables the user to program a 6 byte code representing the local time offset and seasonal time change-over dates for that zone. Please contact your local distributor for further details of this function.

6 - Network Setup

The 47xxN series time zone displays are fitted with a 10/100Base-T Ethernet network interface and designed to synchronise to a remote NTP (Network Time Protocol) time server across a TCP/IP computer network.

Upon initial installation, the unit IP address, subnet mask, gateway and NTP time server IP address shall be automatically assigned by a DHCP server (if available). Alternatively, the unit IP address, subnet mask, gateway and NTP time server IP address can be statically assigned.

The table below details the available network parameters. Please contact your network administrator for details of network configuration & addresses that will allow the clocks to be used on your network.

Fu Nt	Network settings		
Function	Display Type	Description	'Up' button function
	hh:mm		
DHCP Setting	dh Fu	Full DHCP mode. Automatic assignment of IP, Subnet and Gateway by customers DHCP server. Automatic assignment of NTP servers via DHCP option 42.	Exit to Time display
	dh Ye	DHCP mode. Automatic assignment of IP, Subnet and Gateway by customers DHCP server. User setting of NTP server addresses.	Exit to Time display
	dh No	Static assignment of IP, Subnet and Gateway addresses by user. User setting of NTP server addresses.	Select IP Byte 1
IP Byte 1	I 010	IP Address setting 1st Byte / Octet Range 0 - 254	Select IP Byte 2
IP Byte 2	I 001	IP Address setting 2nd Byte / Octet Range 0 - 255	Select IP Byte 3
IP Byte 3	I 000	IP Address setting 3rd Byte / Octet Range 0 - 255	Select IP Byte 4
IP Byte 4	I 100	IP Address setting 4th Byte / Octet Range 0 - 255	Select Subnet Byte 1
Subnet Byte 1	S 255	Subnet Address setting 1st Byte / Octet Range 0 - 255	Select Subnet Byte 2
Subnet Byte 2	S 255	Subnet Address setting 2nd Byte / Octet Range 0 - 255	Select Subnet Byte 3
Subnet Byte 3	S 000	Subnet Address setting 3rd Byte / Octet Range 0 - 255	Select Subnet Byte 4
Subnet Byte 4	S 000	Subnet Address setting 1st Byte / Octet Range 0 - 255	Select Gateway Byte 1
Gateway Byte 1	G 010	Gateway Address setting 1st Byte / Octet Range 0 - 254	Select Gateway Byte 2
Gateway Byte 2	G 001	Gateway Address setting 2nd Byte / Octet Range 0 - 255	Select Gateway Byte 3
Gateway Byte 3	G 000	Gateway Address setting 3rd Byte / Octet Range 0 - 255	Select Gateway Byte 4
Gateway Byte 4	G 001	Gateway Address setting 1st Byte / Octet Range 0 - 255	Exit to Time display

7 - Synchronisation Setup

The 47xxN series time zone displays have a standalone accuracy of better than 0.1 sec/day @ 20-25°C. However, for applications where an increased level of accuracy is required, units may be synchronised to a range of different synchronisation methods.

The synchronisation settings are accessed from the function menu as detailed in section 3.

Fu Sy	Synchronisation settings		
Sync Mode	Description		
	Mode	Range	Option Description
None	Stand alone operation		
NTP	NTP synchronisation on 10/100Base-T Ethernet TCP/IP network.		
	DHCP or IP address		If Clock is set to 'Full DHCP' mode it obtains its ntp server address from the customers DHCP server. If static or DHCP mode is selected the address of the first NTP server should be entered.
GPS	GPS satellites synchronisation (requires 488HS4 or 488HS4-GLONASS receiver)		
48x0	High precision UTC synchronisation code for existing 5200 or 4860 series master clock.		
482	w482 Time code from existing 5200, 4860 or 482D series master clock.		
	Zo	1-F	w482 time code zone that unit will use for synchronisation.
DCF	DCF77 Radio time code synchronisation (requires 484.03 radio receiver)		
MSF	MSF60 Radio time code synchronisation (requires 484.02 radio receiver)		
MOBA	MOBALine time code from ETC or DTS series master clock.		
	Of	+720 -> -720	Offset in minutes of input MOBALine time signal to UTC (in winter time)
1PPS	Contact your local distributor for further information.		
SER	RS232 (requires 4040.2) or RS485 (requires 4040.4) serial ASCII time synchronisation		
	St	WF1, WF2, LUL1, LUL2, LUL3, GPZDA	Time synchronisation from specific format serial message. Contact your local distributor for further information.
	Ba	12 -> 57	Baud rate from 1200 - 57,600 baud
	Bit	7, 8	7 or 8 data bits
	Par	Non, Eve, Odd	Parity: None, Even or Odd
IRIG	1KHz Amplitude Modulated IRIG-B (requires 4040.1)		
EBU	24, 25, 29.97 & 30 fps EBU/SMPTE LTC timecode (requires 4040.E)		
Opt	Fiber optic time synchronisation - Contact local distributor for more info.		
AirT	AirTime Radio synchronisation (requires 4040.A + AirTime RF module)		

NTP Client

47xxN series time zone displays are primarily intended to be synchronised via NTP/SNTP from a remote time server located on the customers TCP/IP Ethernet network. Up to 4 remote NTP time servers can be specified either fully automatically using DHCP option 42 configured on your company's DHCP server or manually by the user.

If manual configuration of the NTP time servers is required, the first server IPv4 address can be programmed using the IR remote or clock switches as detailed below. Up to 3 more time server addresses can be programmed into the digital clock using the cMon clock management software.

Clock configuration

- 1 Press 'Menu' or 'Up' button to access clock settings menu.
- 2 Press '+' button until 'Fu Sy' is displayed
- 3 Press 'Up' button to access Synchronisation menu.
- 4 Press '+' button until 'NTP' is displayed.
- 5 Press 'Up' button.
If Clock is set to 'Full DHCP' mode the display will show DHCP and the 'Up' arrow should be pressed again to return to the time display.
If clock is to 'DHCP' or 'Static' modes the 4 bytes of the first NTP time server address can be programmed in same manner as detailed for the IP address in Section 7.
- 6 Press '+' & '-' buttons until each of the 4 address bytes is displayed.
- 7 Press 'Up' to return to time display

GPS and GLONASS Synchronisation

The 47xxN series time zone displays can be configured to synchronise to GPS or GLONASS time code when connected to either the 488HS4 GPS Receiver or 488HS4-GLONASS Receiver (supplied separately) as follows.

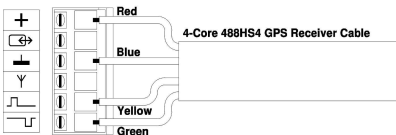

The status of the GPS/GLONASS receiver is shown via the three LEDs on the receiver as follows.

488HS4 GPS receiver status LEDs

Red LED	On	Receiver is powered
Yellow LED	Flash	Receiver is searching for satellites
	On	Receiver is locked to three or more satellites and receiving time information.
Green LED	Flash	GPS receiver locked.

Clock configuration

- 1 Press 'Menu' or 'Up' button to access clock settings menu.
- 2 Press '+' button until 'Fu Sy' is displayed
- 3 Press 'Up' button to access Synchronisation menu.
- 4 Press '+' button until 'GPS' is displayed.
- 5 Press 'Up' button to select GPS synchronisation.

48x0 and w482 Time Code Synchronisation

The 47xxN series time zone displays can be configured to synchronise to 48x0 or w482 time code from a suitable master clock (supplied separately) as follows.

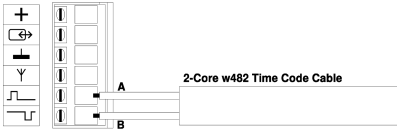

Clock configuration

- 1 Press 'Menu' or 'Up' button to access clock settings menu.
- 2 Press '+' button until 'Fu Sy' is displayed
- 3 Press 'Up' button to access Synchronisation menu.
- 4 Press '+' button until either '48x0' or '482' is displayed.
- 5 Press 'Up' button to enter required w482 time zone number (not required for 48x0).
- 6 Press '+' button until required w482 time zone number is selected (not required for 48x0).
- 7 Press 'Up' button to select either 48x0 or w482 synchronisation.

DCF and MSF Radio Time Code Synchronisation

The 4000E and 4000NE series digital clocks can be configured to synchronise to DCF or MSF radio time code when connected to either the 484.02 MSF Radio Receiver or 484.03 DCF Radio Receiver (supplied separately) as follows..

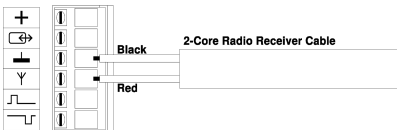

Clock configuration

- 1 Press 'Menu' or 'Up' button to access clock settings menu.
- 2 Press '+' button until 'Fu Sy' is displayed
- 3 Press 'Up' button to access Synchronisation menu.
- 4 Press '+' button until either 'DCF' or 'MSF' is displayed.
- 5 Press 'Up' button to select DCF or MSF synchronisation.

MOBALine Time Code Synchronisation

The 47xxN series time zone displays can be configured to synchronise to MOBALine time code from a suitable master clock (supplied separately) as follows.

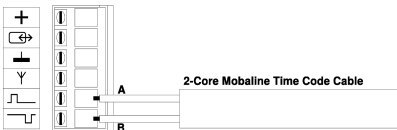

Clock configuration

- 1 Press 'Menu' or 'Up' button to access clock settings menu.
- 2 Press '+' button until 'Fu Sy' is displayed
- 3 Press 'Up' button to access Synchronisation menu.
- 4 Press '+' button until 'MOBA' is displayed.
- 5 Press 'Up' button to set required MOBALine/UTC offset.
- 6 Press '+' button until required MOBALine/UTC offset is displayed in minutes (positive or negative offsets can be set).
- 7 Press 'Up' button to select MOBALine synchronisation.

8a - Display Setup

The 472xN and 474xN series time zone displays can be configured to display time of day, alternating time & date and continuous date in a number of different display formats as detailed in the table below. Date display only available for righthand location.

Fu Di		Display Setup	
Function	Display Type	Description	'Up' button function
	hh:mm		
Display Style	ti	Standard time display.	Exit to Time display
	gb	Alternating time and date in ddmm format.	Display hold time
	us	Alternating time and date in mmdd format.	Display hold time
	eu	Alternating time and date in yymm format.	Display hold time
	cgb	Continuous date in ddmmyy ddmm format.	Exit to Time display
	cus	Continuous date in mmdd format.	Exit to Time display
	ceu	Continuous date in yymm format.	Exit to Time display
	jday	Continuous day of year.	Exit to Time display
Display hold	dh xx	Number of seconds that clock holds between alternating display formats - between 1 and 20 seconds.	Exit to Time display

8b - Calendar Setup

The 470xN and 475xN series time zone displays with either dot matrix alpha-numeric date displays or seven segment numeric date displays. Each of the two display type allow for different date formats as follows.

The 470xN and 475xN series time zone displays with dot matrix style digital calendar can be configured to display the date 6 different formats and in one of 22 different languages.

Fu Cl		Calendar Setup		Up' button function
Function	Format	Description		
Calendar Hold Time	ch xx	Calendar hold time 00 - 30 seconds. If set to 00 only display first calendar mode		Calendar 1 Mode
Calendar 1 Mode	M1 01	THU 26 JUN	Alpha-numeric display of calendar	Calendar 1 Lang.
	M1 02	177 26 JUN	Julian day of year and calendar	Calendar 1 Lang.
	M1 03	W26 26 JUN	Week number and calendar	Calendar 1 Lang.
	M1 04	26 06 14	Numeric date, ddmmyy (GB/UK) format	Calendar 1 Lang.
	M1 05	06 26 14	Numeric date, mmdyy (US) format	Calendar 1 Lang.
	M1 06	14 06 26	Numeric data yymmdd (EU/ISO) format	Calendar 1 Lang.
Calendar 1 Language	C1 GB	Calendar 1 Language as per language table below.		Calendar 2 Mode
Calendar 2 Mode	M2 xx	As mode settings for Calendar 1 above		Calendar 2 Lang.
Calendar 2 Language	C2 xx	Calendar 2 Language as per language table below.		
Calendar 3 Mode	M3 xx	As mode settings for Calendar 1 above		Calendar 3 Mode
Calendar 3 Language	C3 xx	Calendar 3 Language as per language table below.		Calendar 3 Lang.
				Exit to Time display

Please refer to the diagram and table below for further information.

Calendar Language Setup for dot-matrix calendar displays					
Code	Language	Code	Language	Code	Language
CA	Catalonian	GB	English	RU	Russian
CR	Czech	H	Hungarian	S	Swedish
D	German	HR	Croatian	SF	Finnish
DK	Danish	I	Italian	SK	Slovakian
E	Spanish	N	Norwegian	SL	Slovenian
F	French	NL	Dutch	W	Welsh
FO	Faroese	P	Portuguese		
GA	Galician	PL	Polish		

The 470xN and 475xN series time zone displays with seven segment style digital calendar can be configured to display the date 4 different formats.

Fu Cl		Calendar Setup		Up' button function
Function	Format	Description		
Calendar 1 Mode	M1 01	26 06 14	Numeric date, ddmmyy (GB/UK) format	Exit to Time display
	M1 02	06 26 14	Numeric date, mmdyy (US) format	Exit to Time display
	M1 03	14 06 26	Numeric data yymmdd (EU/ISO) format	Exit to Time display
	M1 04	1 77	Numeric Julian day-of-year ddd format	Exit to Time display

9 - Stopwatch Setup

The 47xxN series time zone display can be configured to operate as a multi function stopwatch controlled via the supplied IR remote control.

The clock can be switched between clock and stopwatch modes by pressing the 'Clock' and 'S/W' buttons respectively. The 'Start/Stop' and Hold/Reset' buttons will control the stopwatch operation as per the below table.

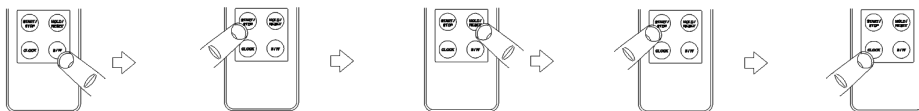

Fu SS		Stopwatch settings	
Function	Display Type	Description	'Up' button function
	hh:mm (4200)		
Stopwatch Mode	Std	Display can be freely switched between clock & stopwatch mode using IR remote control.	Select count direction
	Off	Stopwatch mode is disabled.	Exit to Time display
	Only	Clock mode is disabled.	Select count direction
Count Direction	SA 01	Up from zero. Reset sets count to zero.	Select hold mode
	SA 02	Down from pre-programmed start time & stop at zero.	Select hold mode
	SA 03	Down from pre-programmed start time & then up from zero.	Select hold mode
	SA 04	Down from pre-programmed start time & automatically restart countdown.	Select hold mode
Hold Mode	SB 01	Single, start/stop, start/stop count action. No hold function.	Select display resolution
	SB 02	Start/stop, start/stop count action. Hold action displays accumulated split time.	Select display resolution
	SB 03	Start/stop, start/stop count action. Hold action displays incremental split time.	Select display resolution
	SB 04	Start/stop, start/stop count action. First hold action displays accumulated split time, second rejoins ongoing count.	Select display resolution
	SB 05	Start/stop, start/stop count action. First hold action displays incremental split time, second rejoins ongoing count.	Select display resolution
Display resolution	SC 01	Minutes & seconds	Countdown duration seconds.
	SC 02	Hours & minutes	Countdown duration seconds.
	SC 03	Minutes & seconds up to 59 minutes, 59 seconds, then Hours & minutes	Countdown duration seconds.

	SC 04	Minutes only	Countdown duration seconds.
Countdown duration	00	Set seconds, range 0-59.	Countdown duration minutes.
	00 01	Set minutes, range 0-59.	Countdown duration hours.
	00 01	Set hours, range 0-98.	Exit to time display.

10 - External interface setup

The external interface of the 47xxN series time zone displays can be used for connection of a 406 temperature (supplied separately) or to provide a Local Master synchronisation output..

Fu Et		External Interface Setup		
Function	Display Type		Description	'Up' button function
	hh:mm (4200)	hh:mm:ss (4010)		
External Interface	O ff	Et O ff	External interface disabled (required for use with external stopwatch switches).	Exit to time display
	Ta It	Et Ta It	Display alternating time and temperature display. See 406 documentation for further settings.	Exit to time display
	Tc nt	Et Tc nt	Display continuous temperature display. See 406 documentation for further settings.	Exit to time display
	Lo cl	Et Lo cl	Enable Local Master synchronisation output (can provide synchronisation to a maximum 5 4000E units). See Local Master documentation for further details.	Exit to time display

11 - System setup

The system setup menu contains general setup options for the 47xxN series time zone displays as follows.

Fu St		System Setup		
Function	Display Type		Description	'Up' button function
	hh:mm (4200)	hh:mm:ss (4010)		
Display Brightness	Br A	Br A	Display brightness can be automatically set (A) or set to one of seven fixed levels (1-7)	Select time format
Time Format	24 hr	24 hr	Display time in either 24 hour (military) or 12 hour format.	Display F/W version
Firmware version	01 dd	01 dd	Firmware version clock is running.	Display B/L version
Bootloader version	00 62	00 62	Bootloader version clock is running.	Factory mode.
Factory mode	Eg 00	Eg 00	Factory mode, not user accessible	Exit to time display.