

REDNET D16R

AES3 I/O MKII

User Guide

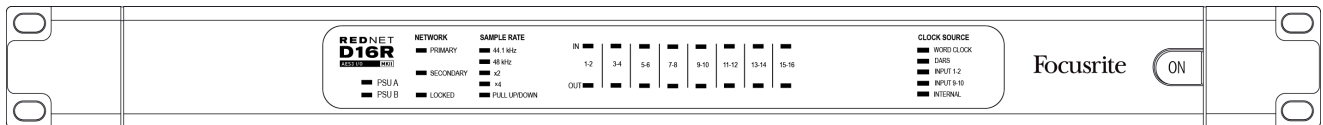

CONTENTS

About this User Guide	3
Box Contents	3
Safety Warning	3
INTRODUCTION	4
INSTALLATION GUIDE	5
RedNet D16R MkII Connections and Features	5
Front Panel	5
Rear Panel	6
Physical Characteristics	8
Power Requirements	8
REDNET D16R MKII OPERATION	9
First Use and Firmware Updates	9
Digital Clocking	9
Pull Up and Pull Down Operation	9
Level Controls	9
Sample Rate Converters	9
OTHER REDNET SYSTEM COMPONENTS	10
REDNET CONTROL 2	10
Status Icons	11
ID (Identification)	11
Tools Menu	11
Signal Routing	12
Clock	12
SRCs	12
AES3 Cut	13
APPENDIX	14
Connector Pinouts	14
Ethernet Connector	14
DB25 (AES59) Connector	14
XLR Connectors	14
PERFORMANCE AND SPECIFICATIONS	15
Focusrite Pro Warranty and Service	17
Registering Your Product	17
Customer Support and Unit Servicing	17
Troubleshooting	17

About this User Guide

This User Guide applies to the RedNet D16R MkII AES3 interface. It provides information about installing and using the unit and how it can be connected into your system.

Should this User Guide not provide the information you need, then please consult: <https://pro.focusrite.com/technical-support>, which contains a comprehensive collection of common technical support queries.

Dante™ and Audinate™ are registered trademarks of Audinate Pty Ltd.

Box Contents

- RedNet D16R MkII unit
- 2 x IEC AC mains cables
- Safety information cut sheet
- Focusrite Pro Important Information Guide, which provides links to:
 - RedNet Control
 - RedNet PCIe drivers (included with RedNet Control download)
 - Audinate Dante Controller (installed with RedNet Control)
 - Dante Virtual Soundcard (DVS) Token and download instructions

Safety Warning



Warning – Shock Hazard

RedNet D16R MkII incorporates dual mains power supplies. Always ensure that both power supply cables are disconnected from the rear panel before opening unit (eg., for servicing)

INTRODUCTION

Thank you for purchasing the Focusrite RedNet D16R MkII.



RedNet D16R MkII is a 1U 19in rack-mount interface featuring 16 channels of AES3 connectivity to and from a Dante audio network – perfect for bridging between digital consoles, power amplifiers or any other AES3 equipped audio equipment and a Dante network.

Dual Ethernet connectors (primary and secondary) on the rear-panel allow maximum network reliability with seamless switchover to a standby network in the unlikely event of a network failure. These ports may alternatively be used to daisy-chain additional units when operating in Switched mode.

Redundant power supplies (PSU A and B) with separate input sockets on the rear panel allow one supply to be connected to an uninterruptible source. Each PSU's status can be monitored remotely over the network or from the front panel.

RedNet D16R MkII provides independent level trim on each input and output channel, and a Sample Rate Converter (SRC) on each input pair allows instant operation with any AES3 source irrespective of the sample rate or clocking of the Dante audio network.

Audio interface is provided by two standard 8-channel (AES59) Combined Digital I/O DB25 connections plus a pair of XLR3 connectors. The XLR3 input replaces input channels 1 and 2 on the DB25 connector, while the XLR3 output replicates DB25 output channels 1 and 2.

S/PDIF input and outputs are provided on RCA connectors; ideal for connecting CD players or solid-state recorders. The input replaces channels 3 & 4 in the DB25 connector while the output can be assigned to replicate any adjacent odd/even pair.

Word Clock I/O on BNC connectors allows synchronisation of the Dante network to house clock, or syncing external equipment to the Dante network. DARS reference can also be accepted via the XLR-3 input connector.

The RedNet D16R MkII front panel contains a set of LEDs to confirm network status, sample rate, clock sources and signal presence on both input and output.

INSTALLATION GUIDE

RedNet D16R MkII Connections and Features

Front Panel

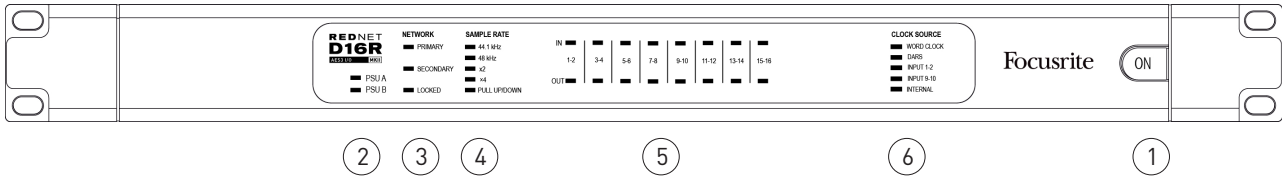

1 AC Power Switch

2 Power Indicator(s)

- **PSU A** – Illuminates when an AC input is applied and all DC outputs are present.
- **PSU B** – Illuminates when an AC input is applied and all DC outputs are present.

When both supplies are functioning and have AC inputs PSU A will be the default supply.

3 RedNet Network Status Indicators:

- **PRIMARY** – Illuminates when the device is connected to an active Ethernet network. Also illuminates to indicate network activity when operating in switched mode.
- **SECONDARY** – Illuminates when the device is connected to an active Ethernet network. Not used when operating in Switched mode.
- **LOCKED** – Illuminates when a valid sync signal is received from the network, or when the RedNet D16R MkII unit is Network Master (or there is a sync to an external clock).

4 RedNet Sample Rate Indicators

Five orange indicators: **44.1 kHz**, **48 kHz**, **x2** (multiple of 44.1 or 48), **x4** (multiple of 44.1 or 48) and sample rate **PULL UP/DOWN**. These Indicators illuminate individually or in combination to indicate the sample rate being used. For example, for a 96kHz Pull Up/Down setting, the 48kHz, x2 and Pull Up/Down indicators will illuminate.

5 Signal Presence LEDs

LEDs indicate whether an input or an output signal is present for each odd/even channel pair. Illuminate at -126 dBFS.

6 Clock source

Five orange indicators: **Word Clock**, **DARS**, **Input 1-2**, **Input 9-10** and **Internal**. Whichever is lit identifies the clock reference being used.

When an incoming clock source is invalid, the 'Locked' indicator will flash to indicate that the unit has reverted to using its internal clock.

Rear Panel

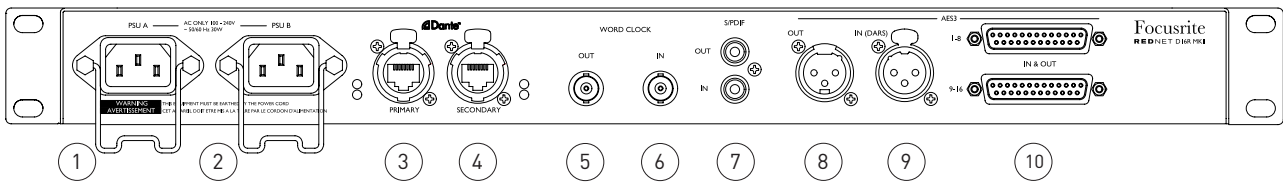

1 IEC Mains Inlet A

Standard IEC receptacle for connection of AC mains. RedNet D16R MkII feature 'Universal' PSUs, enabling them to operate on any supply voltage of between 100 V and 240 V.

2 IEC Mains Inlet B

Input connector for backup mains power source. Power supply B remains on standby but will seamlessly take over if PSU A develops a fault or loses its mains input supply.

If an uninterruptable supply (UPS) is available, it is recommended that this is applied to input B.

3 Primary Network Port

RJ45 etherCON connector for the Dante network. Use standard Cat 5e or Cat 6 network cables to connect RedNet D16R MkII to the Ethernet network switch. Adjacent to each network socket are LEDs which illuminate to indicate a valid network connection plus network activity.

4 Secondary Network Port

Secondary Dante network connection where two independent Ethernet links are being used (Redundant mode) or an additional port on an integral network switch on the primary network (Switched mode).

5 Word Clock Out

BNC connector provides an output of the chosen system clock reference – can be switched between base rate or network rate.

6 Word Clock In

Allows synchronisation of the Dante network to house word clock.

7 S/PDIF:

- **OUT** – Provides any adjacent odd-even signal pair (eg., 3–4, 11–12). Software selectable.
- **IN** – Can be used as an alternative input for audio channels 3–4. Software selectable.

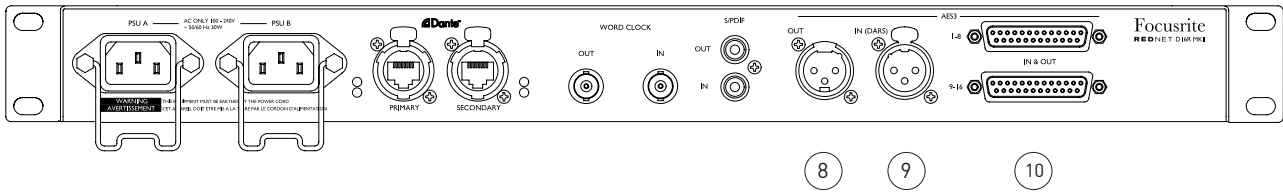

8 AES3 Out

Permanent AES3 output of audio channel pair 1-2 on XLR-3 male connector.

9 AES3 In (DARS)

XLR-3 female connector. Can be used as an alternate AES3 audio source for channels 1-2. Software switchable. May also be used as a clock source when fed with either AES3 or DARS (Digital Audio Reference Signal – AES3 distributed clock as per AES11). Software selectable.

10 AES3 1-8 In/Out

Eight AES3 input and output channels per connector. DB25 female connectors wired to AES59 Combined Digital I/O standard.

See page Appendix I, page 14 for connector pinouts.

Physical Characteristics

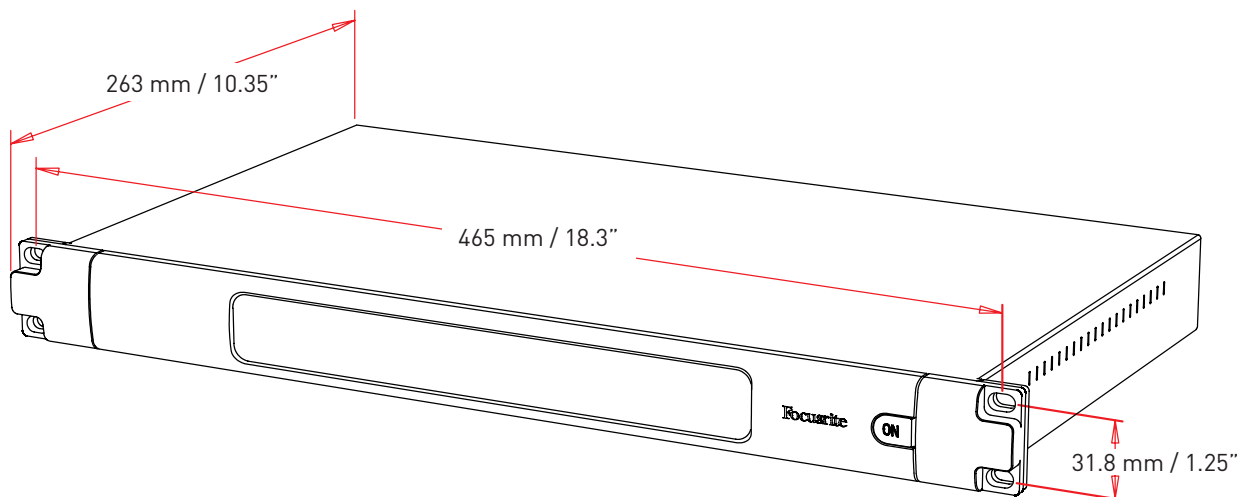

RedNet D16R MkII dimensions are illustrated in the diagram above.

RedNet D16R MkII requires 1U of vertical rack space. Allow an additional 75mm of rack depth behind the unit to allow for cables. Each unit weighs 3.84 kg and for installations in a fixed environment (eg., a studio rack), the front-panel rack mountings* will provide adequate support. However, if the unit is to be used in a mobile situation (eg., flight-cased for touring, etc.), it is recommended that side support rails or shelves are used within the rack.

**Always use M6 bolts and cage nuts specifically designed for 19" equipment racks. An Internet search using the phrase "M6 cage nuts" will reveal suitable components.*

RedNet D16R MkII generates little significant heat and is cooled by natural convection.

Note. The maximum operating environmental temperature is 50°C / 122°F.

Ventilation is via slots in the enclosure at both sides – ensure that when mounted in a rack the vents are not obstructed. Do not mount RedNet D16R MkII immediately above any other equipment which generates significant heat, for example, a power amplifier.

Power Requirements

RedNet D16R MkII is mains-powered. It incorporates 'Universal' power supplies, which can operate on any AC mains voltage from 100 V to 240 V. The AC connections are made via a standard 3-pin IEC connectors on the rear panel.

When PSU A & PSU B are both connected, PSU A becomes the default supply and therefore draws more current than B. If a backup mains supply is provided from an uninterruptable source, it is recommended that this is connected to inlet B.

Two mating IEC cables are supplied with the unit – these should be terminated with mains plugs of the correct type for your country.

The AC power consumption of the RedNet D16R MkII is 30 W.

Please note that there are no fuses in RedNet D16R MkII, or other user-replaceable components of any type. Please refer all servicing issues to the Customer Support Team (see "Customer Support and Unit Servicing" on page 18).

REDNET D16R MKII OPERATION

First Use and Firmware Updates

Your RedNet D16R MkII may require a firmware update* when it is first installed and switched on. Firmware updates are initiated and handled automatically by the RedNet Control application.

**It is important that the firmware update procedure is not interrupted – either by switching off power to the RedNet D16R MkII unit or the computer on which RedNet Control is running, or by disconnecting either from the network.*

From time to time Focusrite will release RedNet firmware updates within new versions of RedNet Control. We recommend keeping all RedNet units up to date with the latest firmware version supplied with each new version of RedNet Control.

Digital Clocking

Each RedNet D16R MkII will automatically lock to a valid Network Master via its Dante connection. Alternatively, If a Network Master is not present, then the unit can be chosen as the Network Master by the user.

Pull Up and Pull Down Operation

RedNet D16R MkII is able to operate at a specified pull up or pull down percentage as selected in the Dante Controller application.

Level Controls

All I/O channels can be individually attenuated by up to 78 dB in 1 dB steps via the RedNet Control graphical interface. Each channel can also be muted or dimmed; the Dim function attenuates a channel by 20 dB.

Sample Rate Converters

SRC will need to be switched in for any sources that are not using the current system clock as a reference signal.

SRC can be switched in or out separately for each input channel pair.

Note that engaging the sample rate converters will increase the overall latency of the device.

OTHER REDNET SYSTEM COMPONENTS

The RedNet hardware range includes various types of I/O interface and the PCIe/ PCIeR digital audio interface cards which are installed in the system's host computer or in a chassis. All the I/O units can be considered as "Break-Out" (and/or "Break-In") boxes to/from the network, and all are built in mains-powered, 19" rackmount housings, unless otherwise stated. There are also three software items, RedNet Control 2 (see below), Dante Controller and Dante Virtual Soundcard.

REDNET CONTROL 2

RedNet Control 2 is Focusrite's customisable software application for controlling and configuring RedNet and Red range interfaces. The system presents an image for each hardware unit, showing its control levels and function settings, signal meters, as well as critical status indicators for power supplies, clock status and the primary/secondary network connections.

The operator's manual for the RedNet Control 2 application can be found here: www.focusrite.com/downloads

Please refer to the section 'Device Control' for further details of device operation and setup using the software.

The single-tab image for the RedNet D16R MkII unit is shown below:

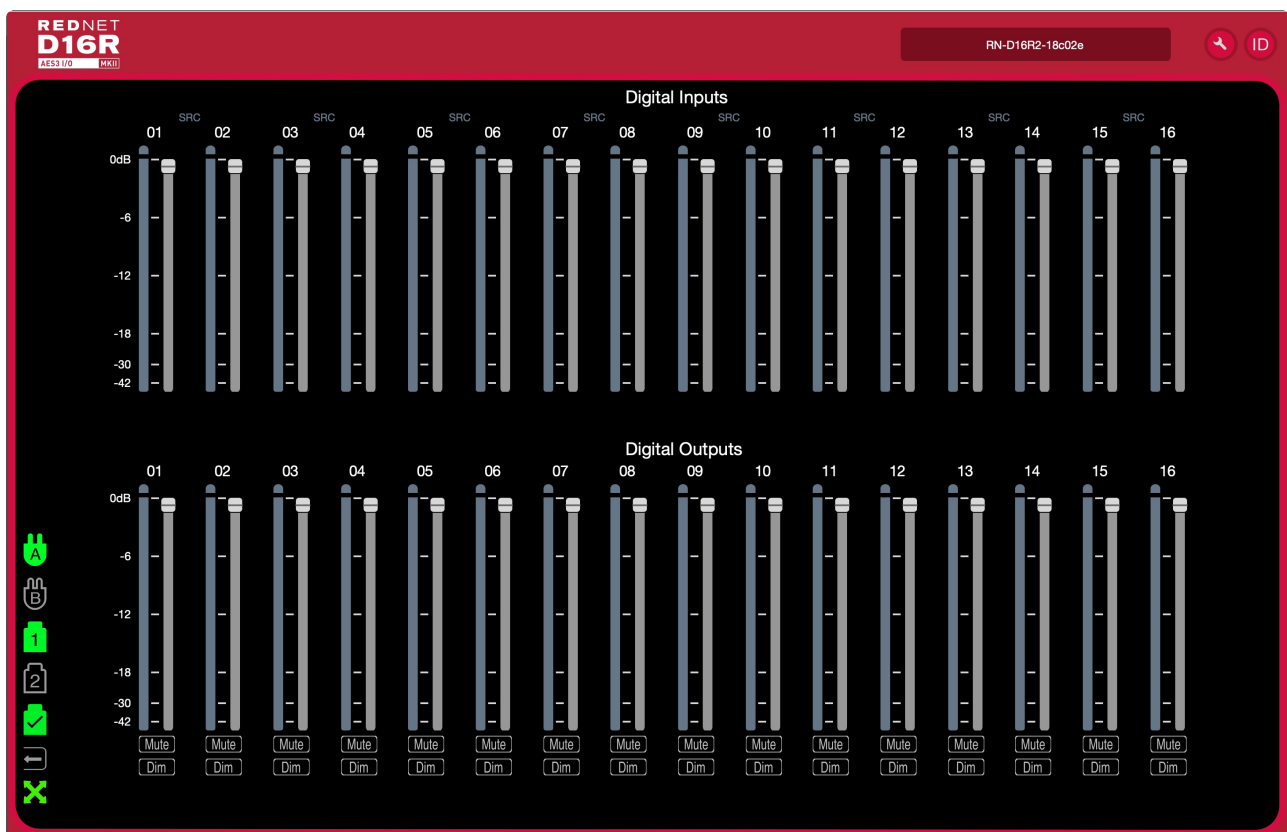

The illustration above shows the Gain control sliders, Level meters and the Mute/Dim buttons for each of the 16 inputs and outputs – the SRCs are not switched in.

Status icons for the PSUs and the network are shown at the left. See next page for icon descriptions.

RedNet Control 2 ...

When a RedNet D16R MkII is added to a tab containing either 6 or 12 devices, the graphical controls are separated into three pages: 'Meters', 'Inputs' and 'Outputs', with I/O split into channels 1-8 or 9-16.

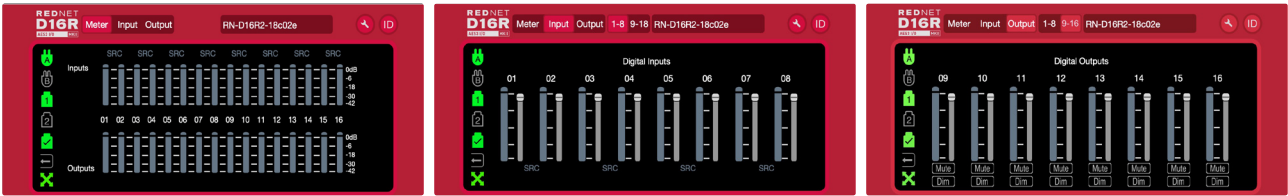

'SRC' Indicates sample rate converters are switched in for an input channel pair.

Status Icons

Status icons for the PSUs and the network are shown at the left of each device window:



PSUs A & B – Each illuminates if PSU has power input and all DC outputs are present

Networks – Each illuminates if a valid connection is present

Locked – Unit is successfully locked to the network (changes to the red cross if not locked)

External Clock – Green: unit is locked to the external source, Yellow: unit is locking,

Red: unit is attempting to identify a network, Off: no network

Network Master – Illuminates if a unit is the network master

ID (Identification)

Clicking on the ID icon  will identify the device being controlled by flashing its front panel LEDs.

Tools Menu

Clicking on the Tools icon  will open the System Settings window. The Settings are grouped into four tabs:

'Signal Routing'

'Clock'

'SRCs'

'AES3 Cut'

The unit's hardware and firmware details, as well as the current device settings, are displayed in the left pane of the window.

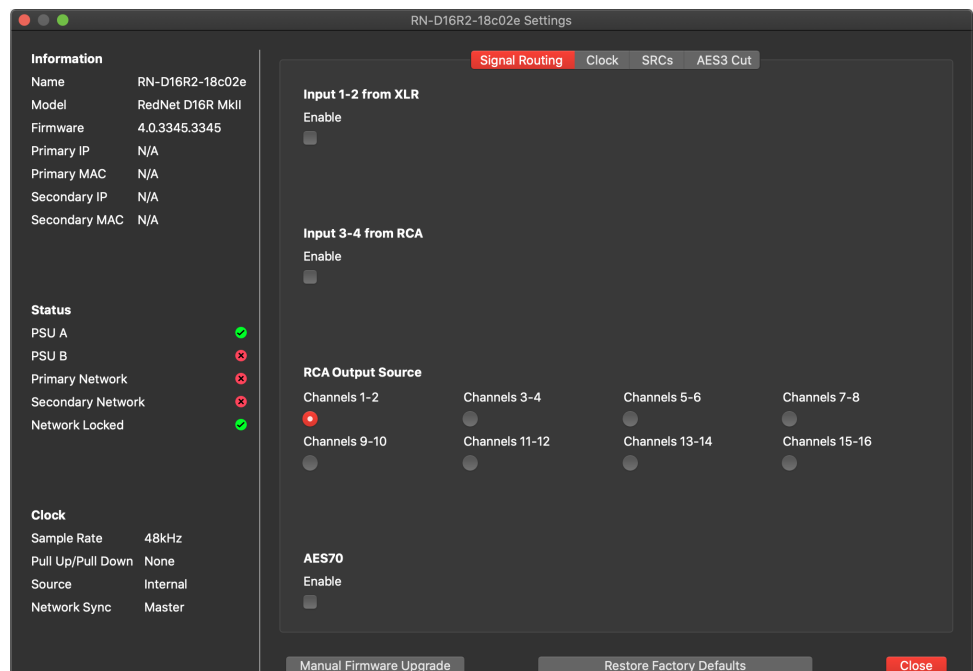

Signal Routing

Input 1–2 from XLR – Tick option On/Off. Replaces channels 1–2 on the DB25 connector.

Input 3–4 from RCA – Tick option On/Off. Replaces channels 3–4 on the DB25 connector.

RCA Output Source – Only one can be selected at any time.

- Channels 1–2
- Channels 3–4
- |
- Channels 15–16

AES70 – On/Off state.

Clock

Preferred Master – On/Off state.

RedNet Clock Source – Only one of the following can be selected at any time.

- Internal (RedNet is network master but running from internal clock)
- External – BNC Input (Word Clock)
- External – XLR Input (DARS or Audio)
- External – DB25 (Input pair 1)
- External – DB25 (Input pair 5)

Note: When selecting any clock source, RedNet DI 6R MkII will become a preferred master.

Word Clock Input Termination – Tick On/Off. (Terminates word clock input BNC with 75Ω.)

Word Clock Output – One can be selected at any time.

- Network
- Network (Base Rate)

SRCs

Sample Rate Converters – Each input channel pair an On/Off toggle. Can be switched separately.

- Channels 1–2
- Channels 3–4
- |
- Channels 15–16

AES3 Cut

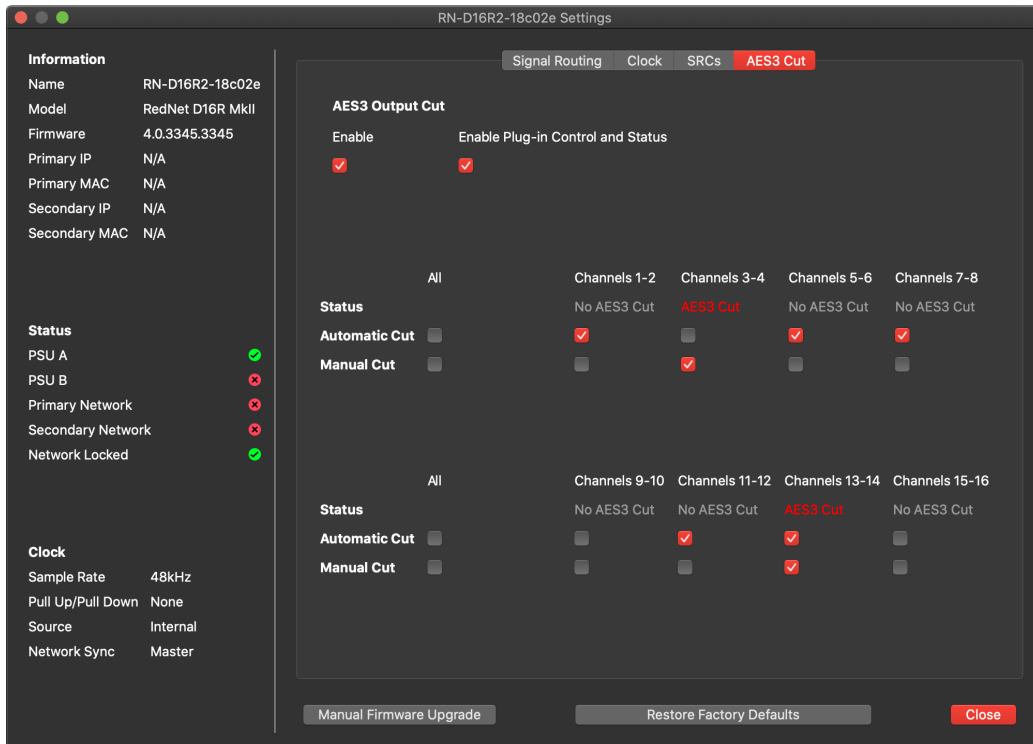

Enable – On/Off toggle.

When the AES3 Output Cut is disabled, the device will always send information (a series of zeroes) on its AES3 outputs, making it impossible for downstream devices, such as amplifiers, to distinguish between ‘mute’ and ‘fault’ state.

Enable Plug-in Control and Status – On/Off toggle.

Automatic Cut – Each channel pair an On/Off toggle. Can be switched separately or All 1-8, 9-16.

Channel pairs can be set to automatically cut the AES3 transmission from the device when there is a network loss or clocking loss, meaning that downstream devices can identify a failure and deal with it appropriately.

Manual Cut – Each channel pair an On/Off toggle. Can be switched separately or All 1-8, 9-16.

APPENDIX

Connector Pinouts

Ethernet Connector

Connector type: RJ-45 receptacle
 Applies to: Ethernet (Dante)

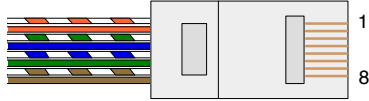

Pin	Cat 5/6 Core
1	White + Orange
2	Orange
3	White + Green
4	Blue
5	White + Blue
6	Green
7	White + Brown
8	Brown

DB25 (AES59) Connector

Connector type: DB25 receptacle
 Applies to: AES3 I/O

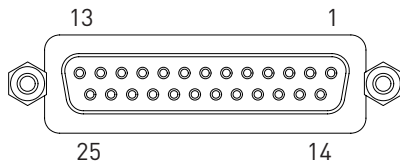

Screw binding-posts use the standard UNC 4/40 thread

Pin	Signal
1	Out channels 7/8 +
14	Out channels 7/8 -
2	Ground
15	Out channels 5/6 +
3	Out channels 5/6 -
16	Ground
4	Out channels 3/4 +
17	Out channels 3/4 -
5	Ground
18	Out channels 1/2 +
6	Out channels 1/2 -
19	Ground
7	In channels 7/8 +
20	In channels 7/8 -
8	Ground
21	In channels 5/6 +
9	In channels 5/6 -
22	Ground
10	In channels 3/4 +
23	In channels 3/4 -
11	Ground
24	In channels 1/2 +
12	In channels 1/2 -
25	Ground
13	n/c

XLR Connectors

Connector type: XLR-3 receptacle
 Applies to: AES3/DARS Input

Connector type: XLR-3 plug
 Applies to: AES3 Output

Pin	Signal
1	Screen
2	Hot (+ve)
3	Cold (-ve)

PERFORMANCE AND SPECIFICATIONS

I/O Level Trim	
Input trim range	Mute, then -78 dB to 0 dB in 1 dB steps (per channel)
Output trim range	Mute, then -78 dB to 0 dB in 1 dB steps (per channel)

Input Sample Rate Converters	
Sample Rate Range	32 to 216 kHz
Gain Error	-0.3 dB
Dynamic Range	> 138 dB (-60 dBFS method)
THD+N	< -130 dB (0.00003%); 0 dBFS input
Latency	11 to 45 samples (network and input sample rate dependent)

Digital Performance	
Supported Sample Rates	44.1 / 48 / 88.2 / 96 / 176.4 / 192 kHz (-4% / -0.1% / +0.1% / +4.167%) at 24 bit
Clock Sources	Internal, Word Clock, DARS, AES input 1-2, AES input 9-10 or from Dante Network Master
External Word Clock Range	Nominal sample rate $\pm 7.5\%$

Rear Panel Connectivity	
AES3	
Channel Count	16 x 16 AES3 channels
Input and Output	2 x DB25 connectors (AES59 Combined I/O / Tascam Digital)
Alternate Input (optional DARS)	1 x Female XLR-3 (replaces DB25 channels 1-2)
Alternate Output	1 x Male XLR-3 (duplicates DB25 channels 1-2)
S/PDIF	
Channel Count	2 x 2 S/PDIF Channels (reduces AES3 input channels)
Input	1 x RCA phono socket (replaces DB25 channels 3-4)
Output	1 x RCA phono socket (switchable, duplicates any DB25 channel pair)
Word Clock	
Input	1 x BNC 75 Ω (switchable termination)
Output	1 x BNC 75 Ω
PSU & Network	
PSU	2 x IEC Inputs with retaining clips
Network	2 x etherCON NE8FBH, also compatible with standard RJ45 connectors (Accommodates rugged etherCON NE8MC* – Does not mate with Cat 6 cable connector NE8MC6-MO and NKE65* cable)

Front Panel Indicators	
PSU A	Green LED. Illuminates when an AC input is applied and all DC outputs are present
PSU B	Green LED. Illuminates when an AC input is applied and all DC outputs are present
Primary Network	Green LED. Indicates that a network connection is present on primary port when in redundant mode. When in Switched mode, a valid network connection at either Primary or Secondary network port will cause this LED to illuminate
Secondary Network	Green LED. Indicates that a network connection is present on secondary port when in redundant mode. Not used in switched mode
Sync Locked	Green LED. When unit is network slave, shows valid network lock. When network master shows unit is locked to indicated clock source. Flashing indicates invalid external clock present and unit has reverted to internal clock
Sample Rate	Orange LED for each: 44.1 kHz, 48 kHz, x2, x4
Pull Up/Down	Orange LED. Indicates unit is set to operate on a Dante pull up/down domain
Signal Indicators	16 Green LEDs: 8 input/8 output indicators. Illuminate at -126 dBFS
Clock Source	Orange LED for each: Internal, Word Clock, DARS, Input 1–2, Input 9–10

Network Modes	
Redundant	Allows unit to connect to two independent networks
Switched	Connects both ports to integrated network switch allowing daisy-chaining of devices

Dimensions	
Height	44.5mm / 1.75" (1RU)
Width	482.6mm / 19"
Depth	263mm / 10.35"

Weight	
Weight	3.84 kg / 8.47 lbs

Power	
PSUs	2 x Internal, 100-240 V, 50/60 Hz, consumption 30 W

Focusrite Pro Warranty and Service

All Focusrite products are built to the highest standards and should provide reliable performance for many years, subject to reasonable care, use, transportation and storage.

Very many of the products returned under warranty are found not to exhibit any fault at all. To avoid unnecessary inconvenience to you in terms of returning the product please contact Focusrite support.

In the event of a Manufacturing Defect becoming evident in a product within 12 months from the date of the original purchase Focusrite will ensure that the product is repaired or replaced free of charge.

A Manufacturing Defect is defined as a defect in the performance of the product as described and published by Focusrite. A Manufacturing Defect does not include damage caused by post-purchase transportation, storage or careless handling, nor damage caused by misuse.

Whilst this warranty is provided by Focusrite the warranty obligations are fulfilled by the distributor responsible for the country in which you purchased the product.

In the event that you need to contact the distributor regarding a warranty issue, or an out-of-warranty chargeable repair, please visit: www.focusrite.com/distributors

The distributor will then advise you of the appropriate procedure for resolving the warranty issue. In every case it will be necessary to provide a copy of the original invoice or store receipt to the distributor. In the event that you are unable to provide proof of purchase directly then you should contact the reseller from whom you purchased the product and attempt to obtain proof of purchase from them.

Please do note that if you purchase a Focusrite product outside your country of residence or business you will not be entitled to ask your local Focusrite distributor to honour this limited warranty, although you may request an out-of-warranty chargeable repair.

This limited warranty is offered solely to products purchased from an Authorised Focusrite Reseller (defined as a reseller which has purchased the product directly from Focusrite Audio Engineering Limited in the UK, or one of its Authorised Distributors outside the UK). This Warranty is in addition to your statutory rights in the country of purchase.

Registering Your Product

For access to Dante Virtual Soundcard, please register your product at: www.focusrite.com/register

Customer Support and Unit Servicing

You can contact our dedicated Focusrite Pro Customer Support team free of charge:

Email: proaudiosupport@focusrite.com

Phone (UK): +44 (0)1494 462246

Phone (USA): +1 (310) 322-5500

Troubleshooting

If you are experiencing problems with your RedNet D16R MkII, we recommend that in the first instance, you visit our Support Help Centre at: <https://pro.focusrite.com/help-centre>